

CLASSIC 13 / CLASSIC 13+

Maytronics Dolphin robotic pool cleaner

EN

User Instructions

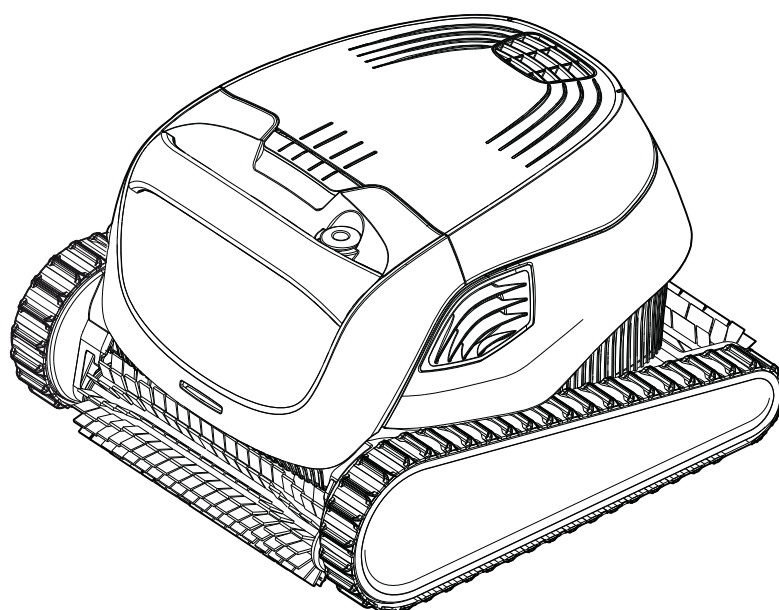

EN

CLASSIC 13 / CLASSIC 13+

Robotic Pool Cleaner

User Instructions

Contents

1. INTRODUCTION	2
2. SPECIFICATIONS	2
3. WARNINGS AND CAUTIONS	2
4. ROBOTIC POOL CLEANER PARTS	4
5. USE THE POOL CLEANER.....	5
5.1 Setup	5
5.2 Place the Pool Cleaner in the water.....	6
5.3 Robot Indicator Lights.....	6
5.4 Remove the Pool Cleaner from the water	7
6. USE THE MyDolphin™ Plus IOT MOBILE APP.....	8
6.1 Getting Started with the MyDolphin™ Plus App.....	8
6.2 Prepare the Pool Cleaner for Connection.....	8
6.3 Activate the Pool Cleaner Using your Mobile Smart Device.....	8
6.4 Led Lights.....	9
7. OFF-SEASON STORAGE.....	9
8. CLEANING THE DUAL FILTER BASKET.....	10
8.1 Cleaning after use - removing and cleaning the dual filter basket.....	10
8.2 Periodic filter cleaning	11
8.3 Clean the Impeller	12
9. TROUBLESHOOTING	13
10. MyDolphin™ Plus - TROUBLESHOOTING.....	14

1. INTRODUCTION

Thank you for purchasing a Maytronics Robotic Pool Cleaner.

We are sure that your Maytronics Robotic Pool Cleaner will provide you with reliable, convenient and cost-effective pool cleaning.

Its reliable filtration in all pool conditions, active brushing, and all-surface climbing brush enhance maximum pool hygiene.

The Robotic Pool Cleaners by Maytronics deliver advanced cleaning technology, long lasting performance and easy maintenance. You and your family will be free to enjoy swimming with full confidence that your pool is completely clean.

2. SPECIFICATIONS

Robot

Motor protection: IP 68

Minimum depth: 0.4m/1.33ft

Maximum depth: 5m/16.4ft

Digital switch-mode power supply

IP 54

Input: 100-125 AC Volt, 200-230 AC Volt, 50-60Hertz, 120 Watt
output: <30 VDC

Bluetooth®/Wifi® Max tras power 10mW EIRR, 2,4 GHz frequency

This product is in accordance with EU Regulation & Directive 2014/531EU.

For full information, please contact us at www.maytronics.com/contact-us-en and ask for the EC declaration of conformity.

3. WARNINGS AND CAUTIONS

IMPORTANT SAFETY INSTRUCTIONS

READ AND FOLLOW ALL INSTRUCTIONS

Please adhere strictly to the following WARNINGS:



Ensure the electrical outlet is protected by a Ground Fault Interrupter (GFI) or an Earth Leakage Interrupter (ELI).



Keep the power supply out of standing water.



Position the power supply at least 3.5m/12ft away from the edge of the pool.



Do not enter the pool while the Pool Cleaner is in the water.



Unplug the power supply before servicing.



Take the Robot Pool Cleaner out of the pool before allowing people to enter the pool.



When examining the Robot Pool Cleaner, disconnect the main power supply.



Ensure that children do not attempt to access Robot Pool Cleaner while it is operating.



Keep the Robot Pool Cleaner out of the reach of children or persons with reduced physical, sensory or mental capabilities, or lack of experience and knowledge, unless they have been given supervision or instruction.



The unit must be connected only to a supply circuit that is protected by a ground-fault circuit interrupter (GFCI). This GFCI should be tested on a routine basis. To test the GFCI, push the test button. The GFCI should interrupt power. Push the reset button. Power should be restored. If the GFCI fails to operate in this manner, the GFCI is defective. If the GFCI interrupts power to the power unit without the test button being pushed, a ground current may be flowing, indicating the possibility of an electric shock. Do not use the power unit. Disconnect the power unit and contact the manufacturer for assistance.



Only an original power cable must be used, at all times. Replaced by a Robot Pool Cleaner certified technician, in case of need to avoid hazard.



To reduce the risk of electric shock replace damaged cord immediately. Do not use extension cord to connect unit to electric supply; provide a properly located outlet.



Use the originally supplied power supply only

Please ensure that the following PRECAUTIONS are implemented:



Operator should keep hands away from driving belt mechanism.



Position the Caddy and power supply at least 3.5m/12ft from pool's edge – during operation.



For continued protection against possible electric shock, the power supply unit should be placed at least 11cm/4in above ground.



When lifting the Robot Pool Cleaner, take care to prevent back injury.



Do not bury cord – locate cord to minimize abuse from lawn mowers, hedge trimmers and other equipment.

When not in use, store the Pool Cleaner on its Caddy in a shaded area. Use the Pool Cleaner in the following water conditions only.

Chlorine	Max 4 PPM
pH	7.0-7.8 PPM
Temperature	6-35°C / 43-95°F (below 15°C / 59°F climbing performance may be affected)
NaCl	Maximum = 5000 PPM

4. ROBOTIC POOL CLEANER PARTS

▶ Robotic Pool Cleaner Model Classic 13/Classic 13+

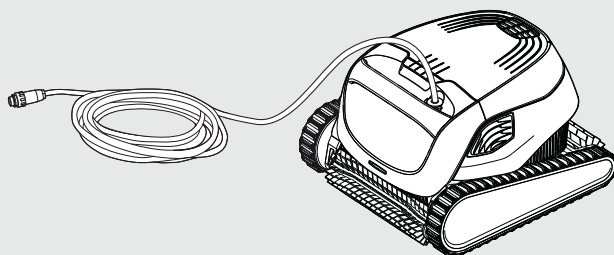

▶ Power supply

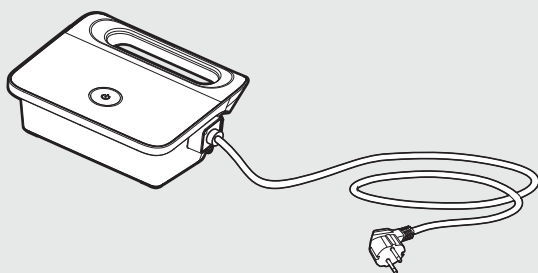

▶ Filtration options

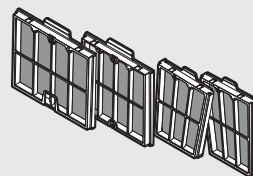
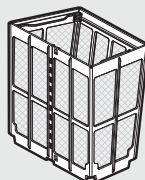
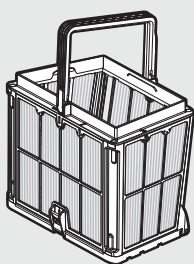

▶ Caddy kit

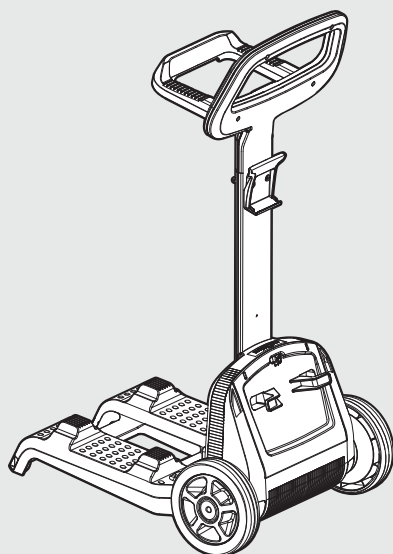

5. USE THE POOL CLEANER

5.1 Setup

The Pool Cleaner is very simple to use. Simply place it in the pool and make sure that it is correctly positioned on the floor of the pool.

Turn it ON and enable it to complete the task.

Before using the Pool Cleaner for the first time, perform the following steps:

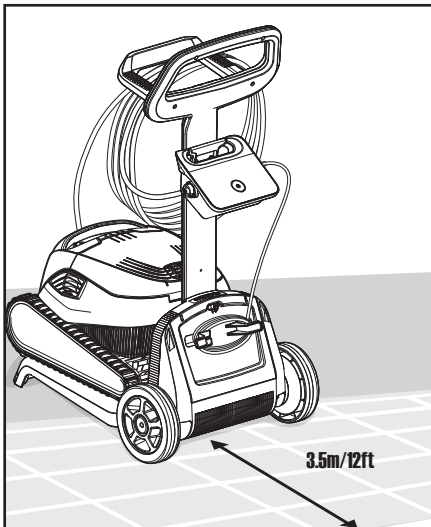

5.1.1 Position the power supply so that it is approximately in the middle of the long side of the pool at a distance of 3.5m/12ft.

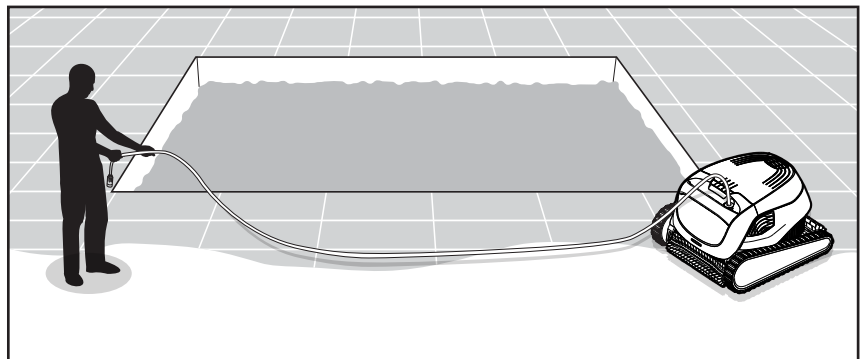

5.1.2 Unwind the blue cable and stretch it out completely so that it has no kinks.

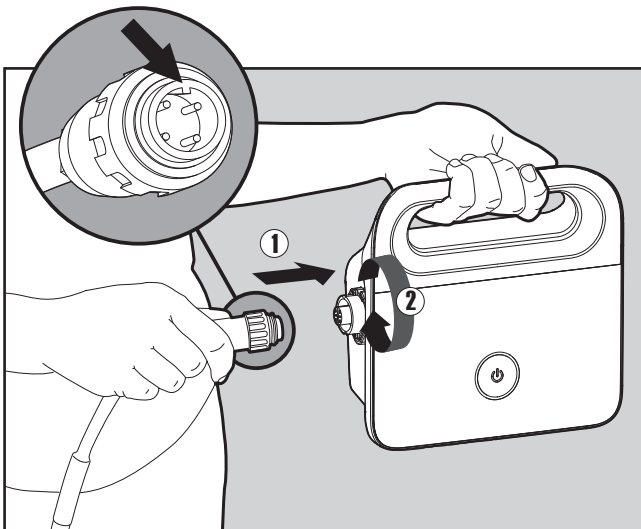

5.1.3 Attach the blue cable to the power supply by inserting it with the notch on the connector (1) lined up to the groove in the socket on the power supply. Turn it clockwise (2).

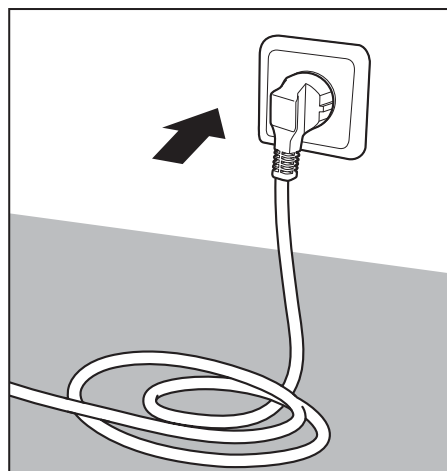

5.1.4 Plug in the power supply and leave it in the OFF position.

5.2 Place the Pool Cleaner in the Water



5.2.1 Place the Pool Cleaner into the pool. Release the Pool Cleaner and let it sink to the floor of the pool. Make sure that the blue cable is free of any obstructions.

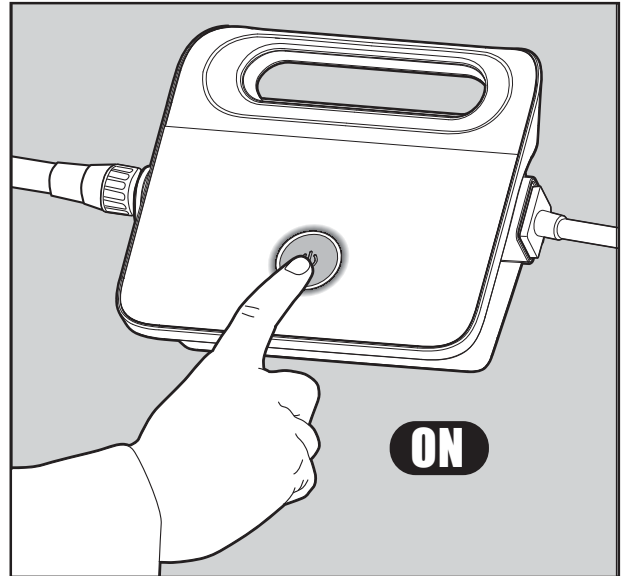

5.2.2 Turn the power supply ON. The Pool Cleaner will now operate until it has reached the end of the cleaning cycle.

5.3 Robot Indicator Lights - For eligible models only

Light	Indication
Blue blinking	Normal operation (additional options available in the App)
Green blinking	Smartphone communication with Pool Cleaner – manual driving navigation

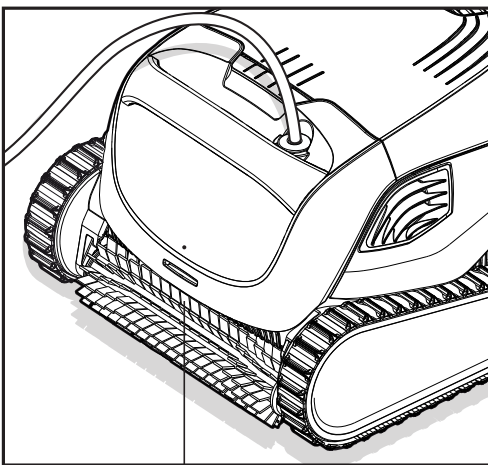

5.3.1 Indicator lights.

5.4 Remove the Pool Cleaner from the Water

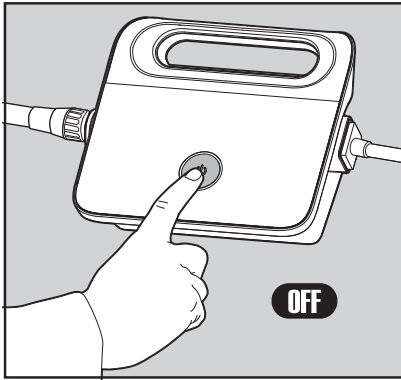

Turn OFF the power supply.



5.4.1



5.4.2 Using the blue cable, bring the Pool Cleaner to the pool edge. Use the handle to remove the Pool Cleaner from the pool.



Please use the cable to pull the robot to the surface, then use the handle.

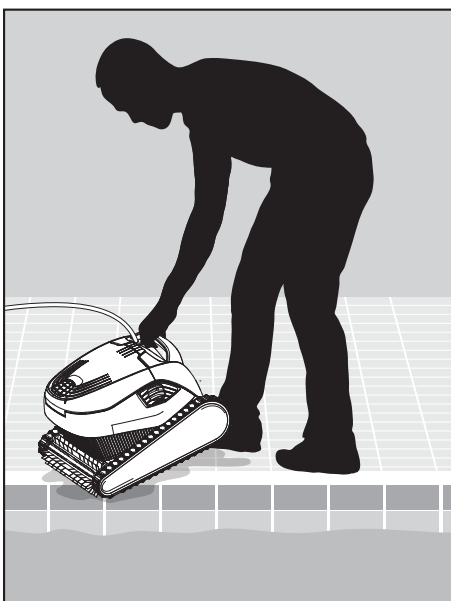

5.4.3 Place the Pool Cleaner on the edge of the pool to let the water drain out.

6. USE THE MyDolphin™ Plus IOT MOBILE APP

Please download the Maytronics **MyDolphin™ Plus** app to your mobile smart device from either Google Play for Android or the Appstore for iOS.

The Maytronics **MyDolphin™ Plus** app is cloud-connected, enabling control from anywhere at anytime, with real-time connectivity.

6.1 Getting Started with the MyDolphin™ Plus App

The app is compatible with the following smart devices:

- Apple (iOS) – version 10 and up – iPhone, iPad, iPod
- Android – version 5 and up operating system

1. Make sure your mobile smart device (phone/tablet) is connected to your home/pool Wi-Fi® network.
2. Make sure you have your Wi-Fi® network name and password in reach.
3. Ensure Bluetooth® is enabled on your smart device.
4. Android users - please make sure your GPS and Location Services are **ON**.
5. For iOS 13 only - while the app is working, enable **Bluetooth® & location**.
6. Please make sure your router is on 2.4Ghz Wi-Fi® frequency only.

6.2 Prepare the Pool Cleaner for Connection

1. Connect the Pool Cleaner to the power supply.
2. The connectivity LED light indicator on your power supply will start flashing **blue**.
3. Place the Pool Cleaner in the water.
4. Press the ON button on your IoT power supply, to start the Pool Cleaner.

6.3 Activate the Pool Cleaner Using your Mobile Smart Device

1. Activate the **MyDolphin™ Plus** app.
2. Click **Agree** and allow all the required permissions.
3. Sign up by creating an account or use your Gmail/Facebook accounts.
4. Scan the QR code located on the side of the power supply.
5. Alternatively, press "**Search for your robot manually**" to pair with your Pool Cleaner.
The app will start pairing with your power supply.
6. Wait for the steady **blue** connectivity LED light and a success message in the app.
7. Connect to your home/pool Wi-Fi® network.
8. Enter the password of your home Wi-Fi® network, and press **CONTINUE**
After a short while, your power supply will flash **green** and **blue**.
9. Wait for the steady **green** connectivity LED light and a success message in the app.

NOTE: Please make sure to fill in the Warranty details and name your Dolphin Pool Cleaner.

6.4 LED Lights

Connectivity LEDs

The connectivity LED light on the power supply has several modes:

1. Flashing **blue** light - waiting for Bluetooth® connection.
2. Steady **blue** light - connected via Bluetooth®.
3. Flashing **green** light - power supply is trying to connect to your home/pool Wi-Fi® network and cloud, or a weak internet signal.
4. Steady **green** light - power supply is now connected to the Wi-Fi® network and to the cloud.
5. Alternating **blue** and **green** light - power supply is connected via Bluetooth® and trying to connect to your home/pool Wi-Fi® network & cloud.

On/Off LEDs

1. Flashing **green** light - waiting for the next operation (delay mode or weekly timer).
2. Alternate **blue/green/red** lights – program updating remotely.
Please wait until process is completed.
3. Steady **red** light – fault. Refer to troubleshooting.

Tips

- If the app is stuck on the same screen for over 2 minutes, close the app and re-open it.
- To test your Wi-Fi® signal strength and quality, play a video via your smart device browser.

7. OFF SEASON STORAGE

If the Pool Cleaner will not be in use for an extended period, perform the following storage steps:

1. Make sure that no water is left in the Pool Cleaner.
2. Thoroughly clean the filter basket and insert them in place.
3. Roll up the cable so that it has no kinks and place on the Caddy.
4. Store the pool cleaner upright on the Caddy in a protected area out of direct sun/rain/frost at a temperature of between 5°-45°C / 41°-113°F.

8. CLEANING THE DUAL FILTER BASKET

Clean the Dual Filter Basket



Unplug the power supply before any servicing activity.



8.1 Cleaning after use - removing and cleaning the dual filter basket

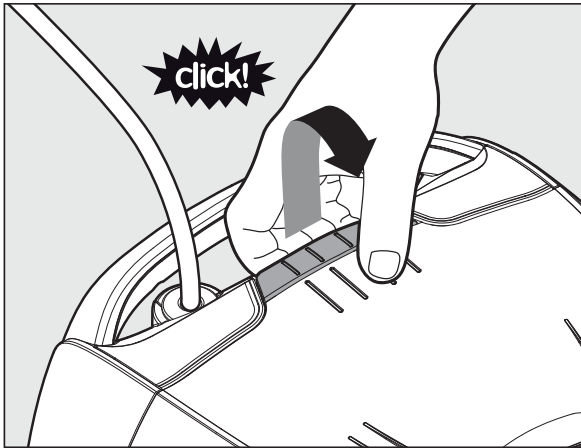

8.1.1 Open the filter cover.

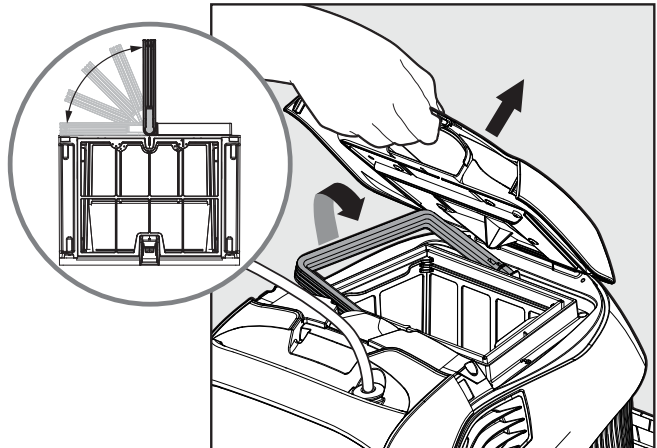

8.1.2 The handle will lift up independently. Lift up the basket.

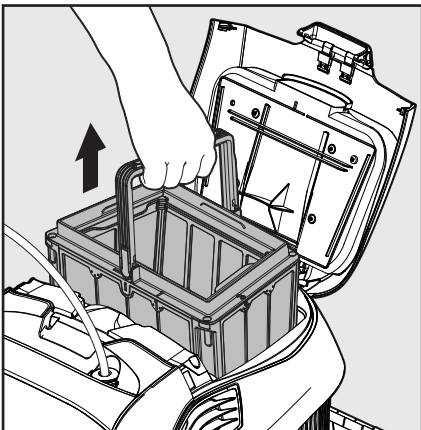

8.1.3 Open the latch to release the bottom lid.

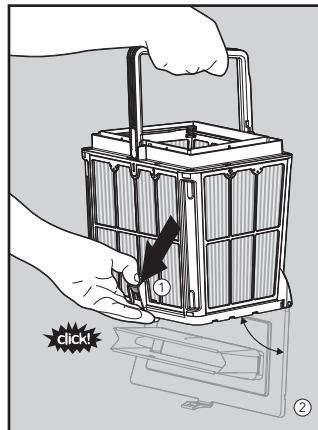

8.1.4 The debris can then be removed.

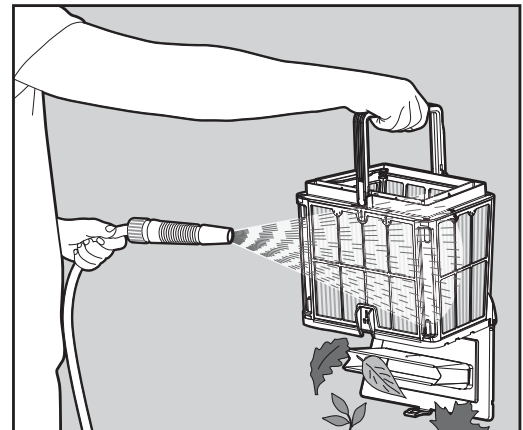

8.1.5 Clean the filter basket with a hose.

8.2 Periodic filter cleaning

In addition to cleaning after use you should clean the filters periodically. It is recommended to do this at least once a month.

When you perform periodic cleaning, you should first dismantle the 4 ultra-fine filter panels of the outer basket, as per the following steps.

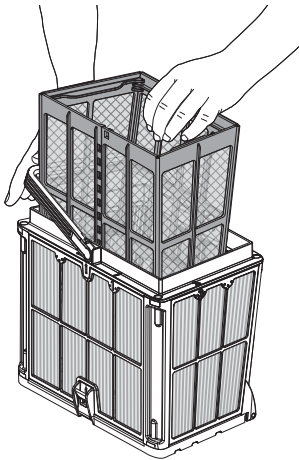

8.2.1 Hold down the handle and remove the inner net basket.

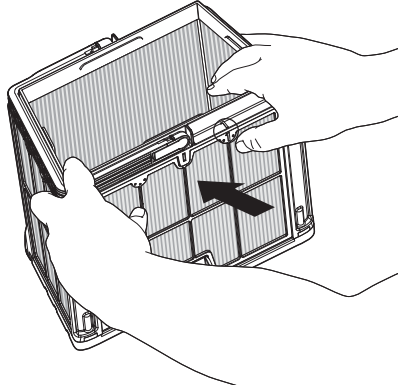

8.2.2 Dismantle the panels using your thumbs to press on panel 1.

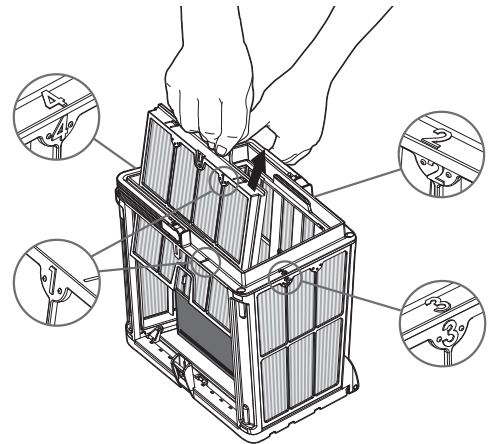

8.2.3 Continue to dismantle panels 2, 3, 4 in the same manner.

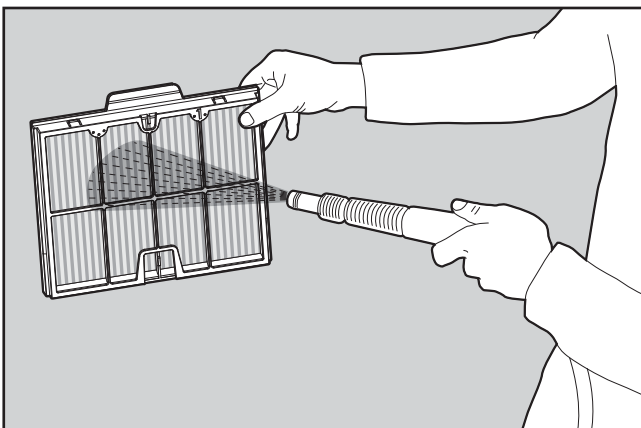

8.2.4 Clean the filter panels with a hose.

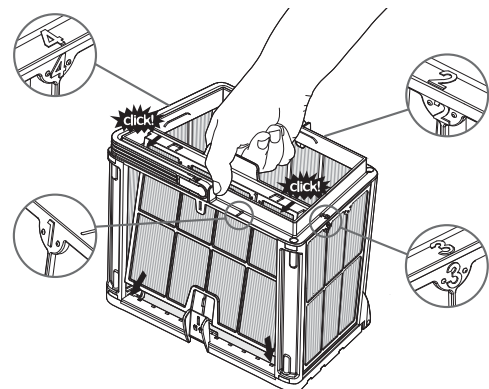

8.2.5 Reassemble the filter panels in the order 4 → 3 → 2 → 1.

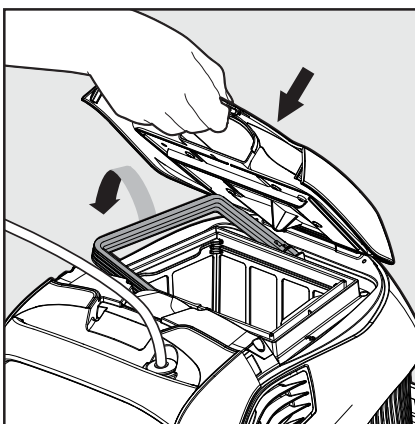

8.2.6 Insert the clean filter basket and close the filter cover.



Do not force the filters into place.

8.3 Clean the Impeller

If there is debris trapped in the impeller it should also be cleaned as follows.

 **Unplug the power supply before any servicing activity.** 

1. Dismantle the impeller cover (images 7.3.1, 7.3.2, 7.3.3)
2. Clean around the impeller housing (image 7.3.4)
3. Reassemble.

Warning: Use a Phillips screwdriver only, not an electric screwdriver.

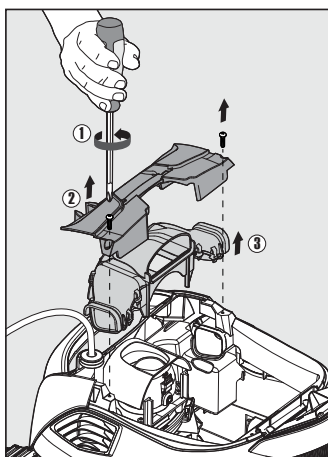

7.3.1

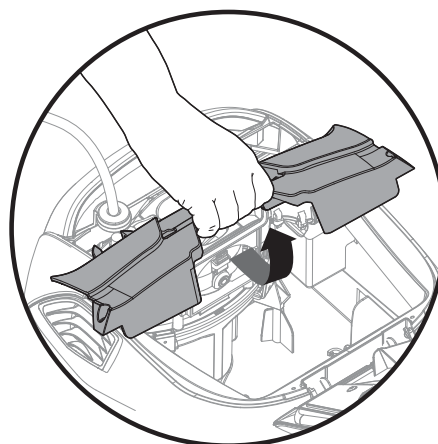

7.3.2

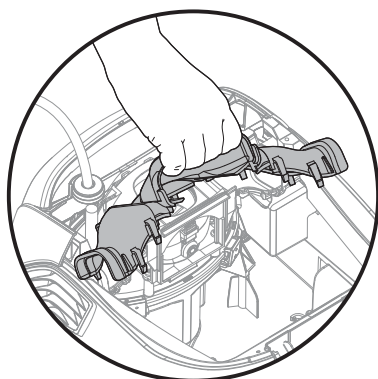

7.3.3

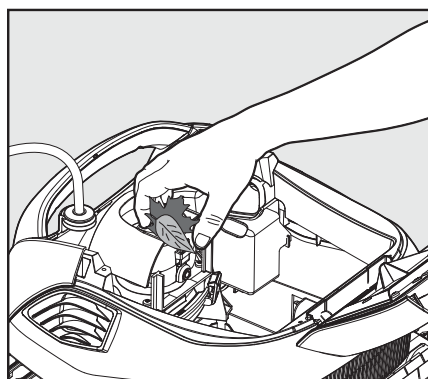

7.3.4

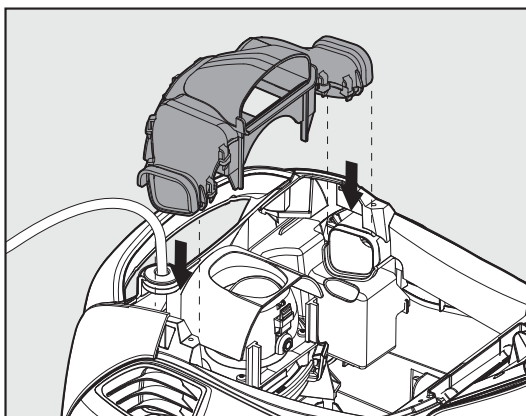

7.3.5

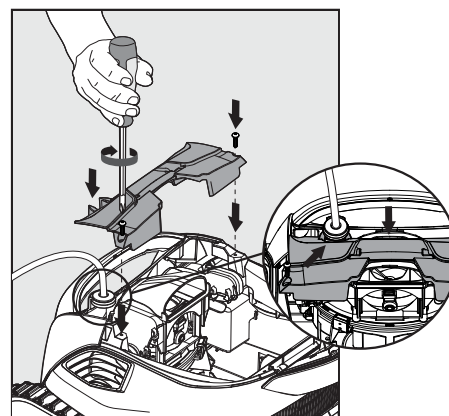

7.3.6

9. TROUBLESHOOTING



Unplug the power supply before performing any action.



Symptom	Possible reason	Corrective action
Power-supply or switch is not working.	<ul style="list-style-type: none"> No voltage in the power socket in the wall. The power supply is not switched ON. Black power cable is not connected into the power supply inlet. 	<ul style="list-style-type: none"> Check that there is voltage in the power socket in the wall. Check that the power supply is plugged in and turned ON. Check that the power cable is securely connected all the way into the power supply. Turn the power supply OFF. Wait 30 seconds, then turn it back ON.
Pool Cleaner does not move / Red light on the power supply.	<ul style="list-style-type: none"> The blue floating cable is not connected into the power supply. An obstacle is blocking the impeller, tracks or wheels. Pool cleaner is out of water. 	<ul style="list-style-type: none"> Check that the blue floating cable is securely connected into the power supply. Unplug the power supply. Open the impeller cover and check that nothing is trapped in the impeller. Verify that nothing is blocking the tracks or wheels.
Pool Cleaner is moving in circles.	<ul style="list-style-type: none"> Clogged filter basket. Debris stuck in the impeller house or impeller cover. Power supply incorrectly positioned. Algae or pool water is out of spec. 	<ul style="list-style-type: none"> Clean the filter basket. Remove debris stuck in the impeller house or impeller cover Place power supply in position so that the Pool Cleaner can freely reach all the pool area. Correct pool and water conditions.
Pool Cleaner does not turn or moves in one direction only.	<ul style="list-style-type: none"> Debris stuck in the impeller house or impeller cover. 	<ul style="list-style-type: none"> Remove debris stuck in the impeller house or impeller cover.
Pool Cleaner moves but does not clean the pool.	<ul style="list-style-type: none"> Clogged filter basket. Debris stuck in the impeller house or impeller cover. 	<ul style="list-style-type: none"> Clean the filter basket. Remove debris stuck in the impeller house or impeller cover.
Pool Cleaner cleans only part of the pool.	<ul style="list-style-type: none"> Power supply incorrectly positioned. Not enough floating cable is released for the correct operation of the Robotic Pool Cleaner. 	<ul style="list-style-type: none"> Place the power supply in a position that enables the Pool Cleaner to freely reach the entire pool area. Check there is enough slack in the blue floating cable for the Pool Cleaner to reach all of the pool. Clean the filter basket.
Blue floating cable has kinks.	<ul style="list-style-type: none"> Clogged filter basket. Debris stuck in the impeller-house or impeller-cover. 	<ul style="list-style-type: none"> Clean the filter basket. Remove debris stuck in the impeller house or impeller cover. To remove the kinks, stretch the floating cable out completely and let it sit for at least a day in the sun.
Pool Cleaner does not climb the walls.	<ul style="list-style-type: none"> Clogged filter basket. Algae on walls. Unsuitable pH level. Debris stuck in the impeller-house or impeller-cover. 	<ul style="list-style-type: none"> Clean the filter basket. Check the level of chemicals in the water. Improper levels may allow the growth of algae, making the walls slippery. Adjust chemical levels and scrub walls. Remove debris stuck in the impeller-house or impeller-cover.

10. MyDolphin™ Plus - TROUBLESHOOTING

Before using the app, make sure you have:

- Cellular connection 3G/4G/5G or Wi-Fi®, with strong signal strength
- Power supply support 2.4Ghz ONLY
- Bluetooth® enabled

Action	What To Do
Pool cleaner does not connect to Wi-Fi®, and the power supply is Flashing green light	power supply is trying to connect to your home/pool Wi-Fi® network and cloud. 1. Weak internet signal. 2. Get the power supply closer to the Wi-Fi® source. 3. Consider use Wi-Fi® extender for a stronger signal.
Second connection after losing router/ Wi-Fi®: How to change to Bluetooth® after first Wi-Fi® /3G connection.	Losing router/ Wi-Fi®: 1. Open the app. The "our cloud services seems to be down" message will appear (can take a few seconds) and the globe on the top bar will turn red. 2. Scroll down and click "choose another solution" which will direct you to the Bluetooth® option. (*this solution will be a one-time solution. Note that in order to continue with Bluetooth® connection, the end user must be near the robot). 3. The app will connect to Wi-Fi® automatically when the connectivity returns. If it doesn't reconnect, restart the app. 4. If network interruptions continue, try to improve the quality of the home router signal (move closer to the router).
Initial connection. How to connect with Bluetooth® only.	Before you start: CONNECT VIA Wi-Fi®, 3G/4G MUST BE OPEN 1. Plug in the power supply. 2. Connect the robot to the power supply. 3. Download the new MyDolphin™ Plus app. 4. Login to the app and allow the required permissions. 5. Scan the QR code and follow the app instructions. 6. Click "go online" (at this stage, iOS users need to minimize the app and re-open it. Android users can click "choose network" and "Later").
How to change to Wi-Fi® after initial Bluetooth® connection.	1. Make sure your Bluetooth® and Wi-Fi® are enabled. 2. Open the MyDolphin™ Plus app and connect to the robot via Bluetooth®. 3. Go to Settings and click "Wi-Fi® Settings". 4. Follow the app instructions to go online.
Changing your Wi-Fi® network.	Router was replaced 1. Log into the app → you will see a connection error. 2. Go to "settings" at the top bar on the screen. 3. Go to "Wi-Fi® settings" → Click "change Wi-Fi® network" → "change to the new Wi-Fi® network" (enter the Wi-Fi® name and passcode) → Click "continue" and wait to receive notification that the robot has been configured to the new Wi-Fi®. 4. Simultaneously, the LED color on the power supply will turn solid green (this is the confirmation that the Wi-Fi® is connected).
For Android users. Power supply replacement for new Wi-Fi® connection.	New power supply for a robot connected through Wi-Fi® 1. Turn on the power supply while it is connected to the robot and let it work for several seconds (it will sync with the robot). 2. Login to the app. A connection error message will appear. 3. Go to "check other solutions". 4. Click on the Bluetooth® icon in the top bar. 5. Click "change connectivity", "set Wi-Fi® connectivity" and then "go online". 6. Enter your Wi-Fi® name and password. You see the home screen. The power supply LED will flash green.

Action	What To Do
<p>For iOS users. Power supply replacement for new Wi-Fi® connection</p>	<p>New power supply for a robot connected through Wi-Fi®</p> <ol style="list-style-type: none"> 1. Turn on the power supply while it is connected to the robot and let it work for several seconds (it will sync with the robot). 2. Login to the app. A connection error message will appear. 3. Go to "settings", on the top bar → click on "robot details" → "disconnect from the robot" → "proceed" → "search for nearby robots" → your robot" → click on "change connectivity" → "set Wi-Fi® connectivity" → "go online". 4. Enter your Wi-Fi® name and password.
<p>Motor unit replacement for unit that was not reported to the support system by the technician.</p>	<ol style="list-style-type: none"> 1. Disconnect the power supply from the wall socket before use. 2. After replacing the motor unit (MU), reconnect the power supply to the wall socket and turn on the power supply. Let the robot work for several seconds. 3. Open the MyDolphin™ Plus app. You will see a connection error. 4. Go to "settings" in the top bar → "robot details" → "disconnect from the robot" → "Proceed" → "search for nearby robots" find and select the "new Dolphin MU s/n" → a "is this your robot?" message will appear. After checking the s/n number, press "Yes this is my robot" → The MU will link to robot and the app → home screen. <p>If you do not recognize the serial number, press to add the robot s/n manually or scan the QR Code.</p>

If these solutions do not solve your problem, contact Maytronics Customer Care:

North America

1-888-365-7446 ext. 1002
customersupport@maytronicsus.com

France

+33 (0)4 42 98 14 90
support@maytronics.fr

Australia, NZ, South Africa

1 300 693 657
infoau@maytronics.com

Rest of the world / Maytronics HQ

00 800 69694141 (toll free number)
00 972 77 96 14 204 (international call)
wecare@maytronics.com

For full information and additional troubleshooting please visit us at: www.maytronics.com